

Grommet Isolators

LORD Grommet Isolators provide effective, economical vibration isolation for light loads. They are suitable for commercial and military applications including computers, disk drives, business machines, precision instrumentation and general industrial equipment.

Grommet Isolators are designed and produced with the same kind of precision and care as our high performance bonded elastomeric mounts. This provides close control of stiffness and dimensions. You get the performance and quality you need at low cost.

Grommet Isolators are made of neoprene and natural rubber. They provide good vibration isolation for disturbing frequencies above 30 Hz.

Features and Benefits

- Economical
- Offer improved reliability in environments where harsh vibration and shock occur
- Space saving
- Oil resistant
- Effective vibration isolation and shock protection for light load applications

Table 1 – Specifications and Dimensions

| Part Number | Figure | Elastomer ② | Maximum Axial Load | | Axial Spring Rate | | Radial Spring Rate | | Thread Size | Ferrule Part Number |
|--------------|--------|----------------|--------------------|----|-------------------|------|--------------------|------|--------------|---------------------|
| | | | lb | N | lb/in | N/mm | in/in | N/mm | | |
| J-3112-5-1 | 1 | NR | 1 | 4 | 22 | 3.9 | 44 | 7.7 | — | — |
| J-3112-12-1 | 3 | NR | 1 | 4 | 22 | 3.9 | 44 | 7.7 | # 8 Screw | Y-10879-B |
| J-3112-2-2 | 2 | OR | 2 | 9 | 33 | 5.8 | 66 | 11.6 | — | — |
| J-3112-1-3 | 1 | OR | 3 | 13 | 50 | 8.8 | 100 | 17.5 | — | — |
| J-3112-8-3 | 3 | OR | 3 | 13 | 50 | 8.8 | 100 | 17.5 | # 8 Screw | Y-10879-B |
| J-3112-8-11 | 3 | OR | 5.7 | 25 | 190 | 33.3 | 380 | 66.5 | # 8 Screw | Y-10879-B |
| J-3112-8-6 | 3 | OR | 6 | 27 | 100 | 17.5 | 200 | 35.5 | # 8 Screw | Y-10879-B |
| J-17736-1 ① | 4 | OR | 1 | 4 | 17 | 3.0 | 17 | 3.0 | — | — |
| J-17736-7 ① | 5 | OR | 1 | 4 | 17 | 3.0 | 17 | 3.0 | # 6 Screw | Y-31124-7-1 |
| J-17736-8 ① | 5 | OR | 2 | 9 | 33 | 5.8 | 33 | 5.8 | # 6 Screw | Y-31124-7-1 |
| J-17736-4 ① | 6 | OR | 2 | 9 | 33 | 5.8 | 33 | 5.8 | # 6-32UNC-2B | Y-31124-4-1 |
| J-2927-4-1 ① | 8 | OR | 1 | 4 | 16 | 2.8 | 16 | 2.8 | # 10 Screw | Y-4045-B |
| J-2927-4-2 ① | 8 | OR | 2 | 9 | 32 | 5.6 | 32 | 5.6 | # 10 Screw | Y-4045-B |
| J-2924-4 ① | 7 | OR | 4 | 18 | 65 | 11.4 | 65 | 11.4 | — | — |
| J-2927-1-4 ① | 8 | OR | 4 | 18 | 65 | 11.4 | 65 | 11.4 | # 10 Screw | Y-4045-B |

① Not recommended for Radial Static Load.

② NR = Natural Rubber
OR = Oil-Resistant Elastomer - Neoprene

Table 2 – Specifications and Dimensions

| Part Number | Spacer ③ | | | | Support Member Plate ④ | | | |
|--------------|----------|------|-------|-----|------------------------|-----|----------|------|
| | Length | | O.D. | | Thickness | | Diameter | |
| | in | mm | in | mm | in | mm | in | mm |
| J-3112-5-1 | 0.365 | 9.3 | 0.255 | 6.5 | 0.062 | 1.6 | 0.555 | 14.1 |
| J-3112-12-1 | — | — | — | — | 0.062 | 1.6 | 0.555 | 14.1 |
| J-3112-2-2 | 0.365 | 9.3 | 0.175 | 4.4 | 0.062 | 1.6 | 0.555 | 14.1 |
| J-3112-1-3 | 0.365 | 9.3 | 0.255 | 6.5 | 0.062 | 1.6 | 0.555 | 14.1 |
| J-3112-8-3 | — | — | — | — | 0.062 | 1.6 | 0.555 | 14.1 |
| J-3112-8-11 | — | — | — | — | 0.062 | 1.6 | 0.555 | 14.1 |
| J-3112-8-6 | — | — | — | — | 0.062 | 1.6 | 0.555 | 14.1 |
| J-17736-1 ① | 0.365 | 9.3 | 0.175 | 4.4 | 0.062 | 1.6 | 0.555 | 14.1 |
| J-17736-7 ① | — | — | — | — | 0.062 | 1.6 | 0.555 | 14.1 |
| J-17736-8 ① | — | — | — | — | 0.062 | 1.6 | 0.555 | 14.1 |
| J-17736-4 ① | — | — | — | — | 0.062 | 1.6 | 0.555 | 14.1 |
| J-2927-4-1 ① | — | — | — | — | 0.062 | 1.6 | 0.735 | 18.7 |
| J-2927-4-2 ① | — | — | — | — | 0.062 | 1.6 | 0.735 | 18.7 |
| J-2924-4 ① | 0.455 | 11.6 | 0.195 | 5.0 | 0.062 | 1.6 | 0.735 | 18.7 |
| J-2927-1-4 ① | — | — | — | — | 0.062 | 1.6 | 0.735 | 18.7 |

① Not recommended for Radial Static Load.

④ Tolerance is ± 0.005 in (± 0.127 mm).

③ Spacer recommended for positive tightening if ferrule is not used. Not supplied by LORD.

Figure 1 – Part Dimensions - J-3112 Series (Without Ferrule)

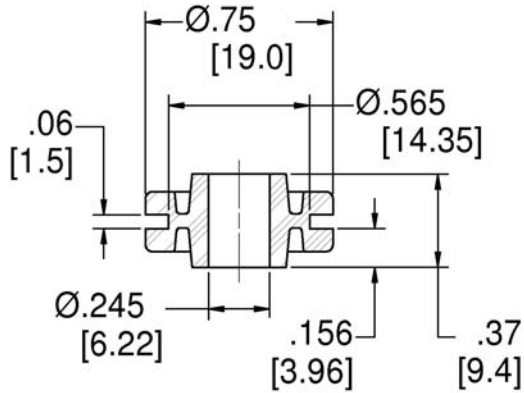

Figure 2 – Part Dimensions - J-3112 Series (Without Ferrule)

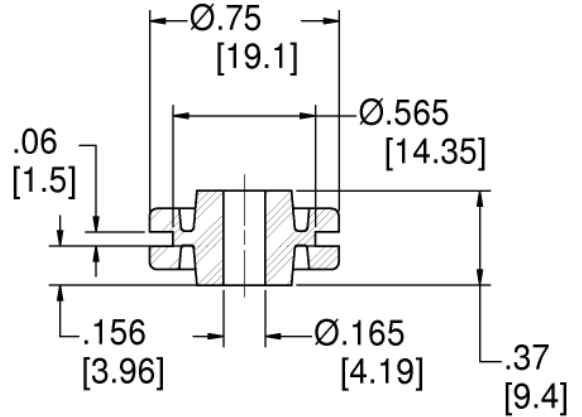

Figure 3 – Part Dimensions - J-3112 Series (#8 Screw, With Plain Ferrule)

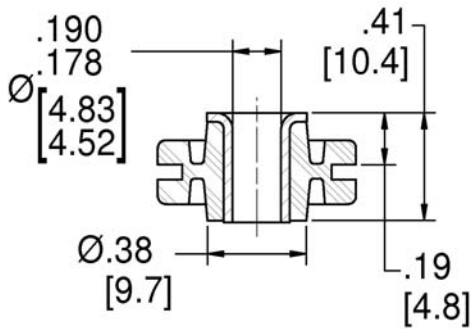

Figure 4 – Part Dimensions - J-17736 Series (Without Ferrule)

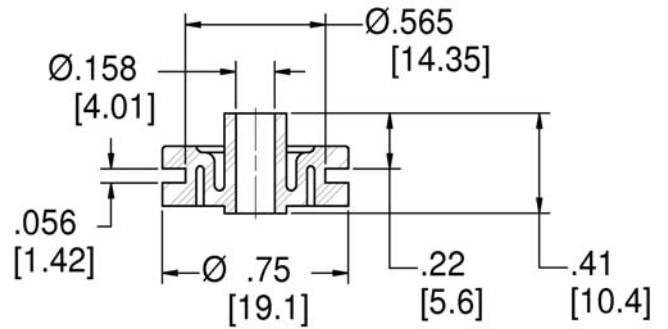

Figure 5 – Part Dimensions - J-17736 Series (#6 Screw, With Ferrule)

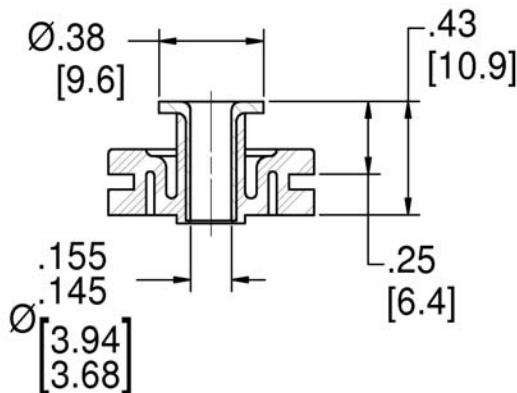
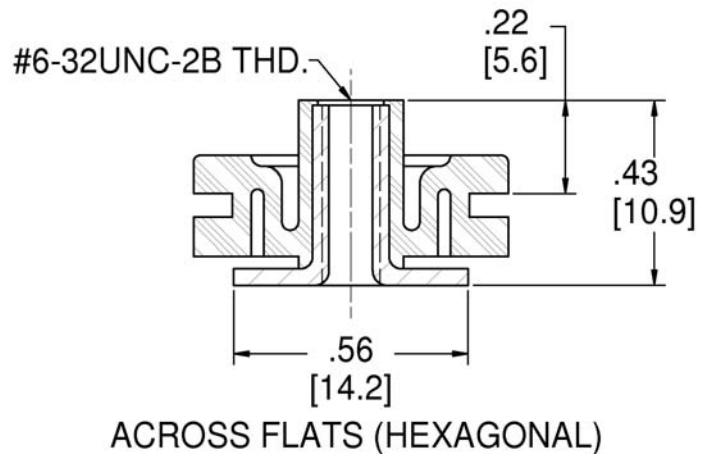
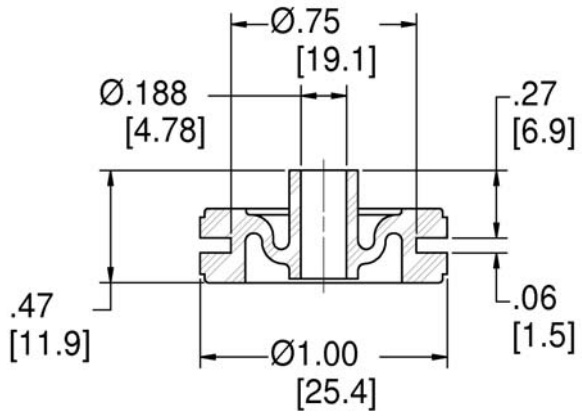

Figure 6 – Part Dimensions - J-17736 Series (With Threaded Ferrule)



**Figure 7 – Part Dimensions - J-2924/2927 Series
(Without Ferrule)**



**Figure 8 – Part Dimensions - J-2924/2927 Series
(#10 Screw, With Plain Ferrule)**

